

# EL Connector

4.5mm pitch / disconnectable crimp style wire-to-wire connectors

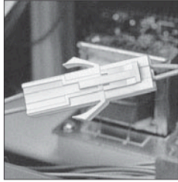

## EL CONNECTOR

4.5mm pitch / Disconnectable Crimp style Wire-to-wire connectors

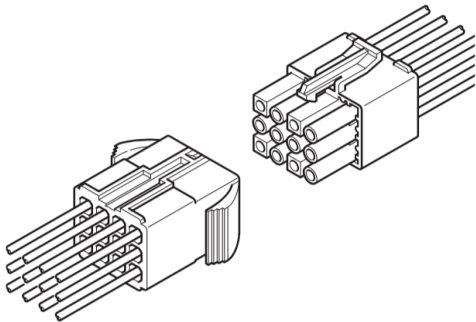

The contacts for the compact EL connector can be easily inserted into the connector housings. The plug housing and the receptacle housing can be smoothly mated even if they are mechanically distorted.

- Easy insertion and secure installation of contacts
- A smooth connection even when pried during mating
- Durable arm lock mechanism
- Two contact styles
- Interchangeability with ML connector

### Specifications

- Current rating: 10A AC, DC max.
  - Voltage rating: 300V AC, DC max.
  - Temperature range: -25°C to +90°C (including temperature rise in applying electrical current)
  - Contact resistance: Initial value/7m Ω max. After environmental testing/10m Ω max.
  - Insulation resistance: 1,000M Ω min.
  - Withstanding voltage: 1,500V AC/minute
  - Applicable wire: AWG #26 to #16 (0.13 to 1.25mm<sup>2</sup>)
  - Applicable panel thickness: 0.8 to 2.0mm
- \* RoHS compliant products are published.  
\* Refer to "General Instruction and Notice when using Terminals and Connectors" at the end of this catalog.  
\* Contact JST for details.

Note: The current rating varies depending on the number of circuits and the wire size used in each connector. The table below lists the current rating as a function of the number of circuits and the wire size.

Current unit : A

Circuits	Wire size (AWG)					
	#16	#18	#20	#22	#24	#26
2	10	6	5	4	4	3
3	10	6	5	4	4	3
4	10	6	5	4	4	3
6	8	5	4	3	3	3
9	6	4	3	3	2	2
12	6	4	3	3	2	2
15	6	4	3	3	2	2

### Standards

- Recognized E60389
- Certified LR20812
- R75052

### Assembly layout and Panel layout

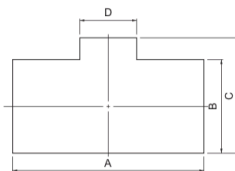
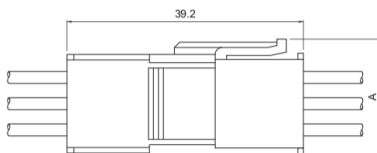

Circuits	Dimensions A (mm)
2 ~ 4 (Single-line arrangement)	10.4
4 (Double-line arrangement)	15.0
6	14.9
9 ~ 15	19.4

Circuits	Receptacle housing Model No.	Panel hole dimensions (mm)				General tolerance ±0.13	Applicable panel thickness (mm)
		A	B	C	D		
2	ELR-02V	15.0	6.0	6.85	5.2	0.8~2.0	
3	ELR-03V	19.7	6.0	6.85	5.2		
4	ELR-04V	24.2	6.0	6.85	5.2		
	ELR-04NV	15.6	10.6	11.6	5.2		
6	ELR-06V	19.7	10.2	11.1	5.2		
9	ELR-09V	19.7	14.8	15.7	5.2		
12	ELR-12V	24.2	14.8	15.7	5.2		
15	ELR-15V	28.7	14.8	15.7	5.2		

- Note: 1. Punch holes in the panel according to the sketch and table shown above. Burrs must be removed.  
2. The strength of the panel must be considered when punching two or more holes.  
3. The connector must be inserted from the same side as the hole is punched.

# EL Connector

## 4.5mm pitch / disconnectable crimp style wire-to-wire connectors

### Contact

#### Pin contact

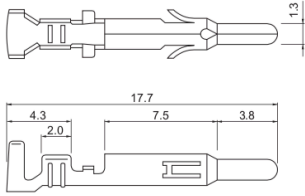

#### Socket contact

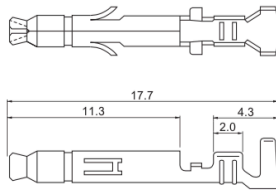

Model No.		Applicable wire		Insulation O.D. (mm)	Q'ty/reel
Pin contact	Socket contact	mm <sup>2</sup>	AWG #		
SLM-01T-P1.3E	SLF-01T-P1.3E	0.13 ~ 0.5	26 ~ 20	1.3 ~ 2.7	6,000
SLM-41T-P1.3E	SLF-41T-P1.3E	0.5 ~ 1.25	20 ~ 16	1.9 ~ 3.4	4,000
*SLM-42T-P1.3E	*SLF-42T-P1.3E	0.3+0.3 ~ 0.5+0.5	22+22 ~ 20+20	1.7+1.7 ~ 2.0+2.0	

#### Material and Finish

Phosphor bronze, tin-plated (reflow treatment)

#### RoHS compliance

- Note: 1. Contact denoted by \* is used for two wires.
- 2. Contact JST for special products.
- 3. Contact JST for brass products.

Contact	Crimping machine	Applicator		
		Crimp applicator	Dies	Crimp applicator with dies
SLM-01T-P1.3E	AP-K2N	MKS-L	MK/SLF/M-01-13E	APLMK SLF/M01-13E
SLF-01T-P1.3E		*MKS-SC	SC/SLF/M-01-13E	APLSC SLF/M01-13E
SLM-42T-P1.3E		MKS-L	MK/SLF/M-42-13E	APLMK SLF/M42-13E
SLF-42T-P1.3E		—	—	—
SLM-41T-P1.3E		MKS-L	MK/SLF/M-41-13E	APLMK SLF/M41-13E
SLF-41T-P1.3E		*MKS-SC	SC/SLF/M-41-13E	APLSC SLF/M41-13E

Note: \*Strip-crimp applicator

### Contact position location numbers

Contact position numbers are stamped

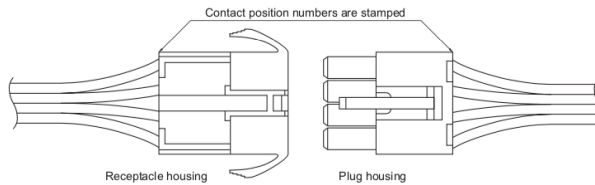

Receptacle housing

Plug housing

#### Receptacle housing

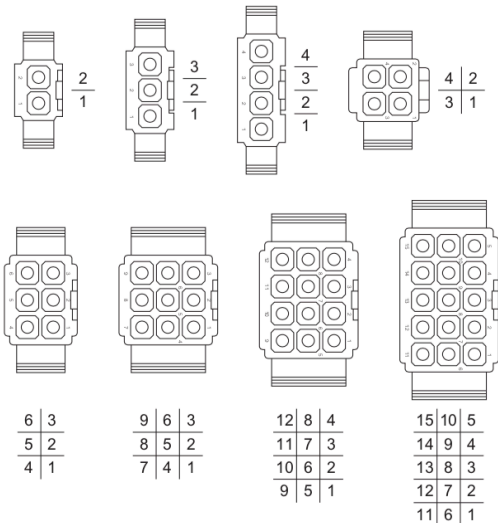

#### Plug housing

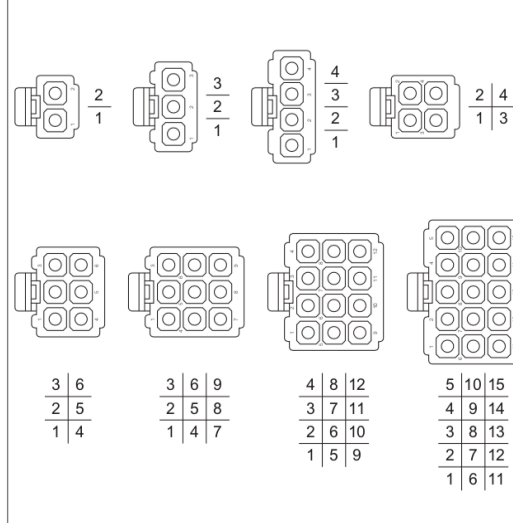

# EL Connector

## 4.5mm pitch / disconnectable crimp style wire-to-wire connectors

### Housing

Material: PA 6, UL94V-0, white

Circuits	Voltage rating	Current rating	Receptacle housing (for pin contact)		Plug housing (for socket contact)	
2	300V	10A	<b>ELR-02V</b> 	Q'ty/ bag 500	<b>ELP-02V</b> 	Q'ty/ bag 500
			<b>ELR-02VF</b> 	Q'ty/ bag 500		
3	300V	10A	<b>ELR-03V</b> 	Q'ty/ bag 500	<b>ELP-03V</b> 	Q'ty/ bag 500
4	300V	10A	<b>ELR-04V</b> 	Q'ty/ bag 500	<b>ELP-04V</b> 	Q'ty/ bag 500
			<b>ELR-04NV</b> 	Q'ty/ bag 500	<b>ELP-04NV</b> 	Q'ty/ bag 500
			<b>ELR-04NVF</b> 			
6	300V	8A	<b>ELR-06V</b> 	Q'ty/ bag 500	<b>ELP-06V</b> 	Q'ty/ bag 500

RoHS compliance

# EL Connector

## 4.5mm pitch / disconnectable crimp style wire-to-wire connectors

### Housing

Material: PA 6, UL94V-0, white

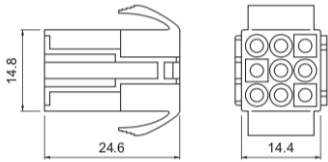
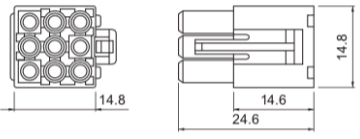
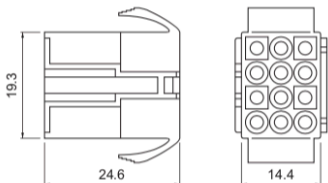
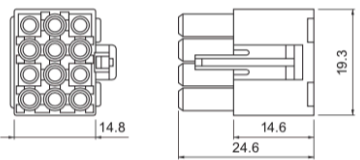
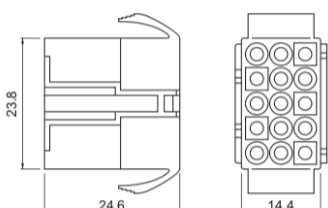
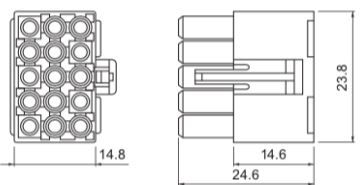
Circuits	Voltage rating	Current rating	Receptacle housing(for pin contact)		Plug housing(for socket contact)	
9	300V	6A	<b>ELR-09V</b> 	Q'ty/ bag 500	<b>ELP-09V</b> 	Q'ty/ bag 500
12	300V	6A	<b>ELR-12V</b> 	Q'ty/ bag 500	<b>ELP-12V</b> 	Q'ty/ bag 500
15	300V	6A	<b>ELR-15V</b> 	Q'ty/ bag 500	<b>ELP-15V</b> 	Q'ty/ bag 500

**RoHS compliance**

Note: 1. ELR-02VF and ELR-04NVF are exclusively for free hanging. The other circuits can be used either for panel mounted or free hanging. The panel hole dimensions are given on the next page.  
2. Contact JST for special products.